



Operation Manual

Shodex^P RI-504

Refractive Index Detector

READ this operation manual **CAREFULLY** before using
Shodex[®] RI-501 Refractive Index Detector.

Copyright X 2015, **SHOKO SCIENCE CO.,LTD** Printed in Japan.

All rights reserved. Contents of this publication may not be reproduced in any form or by any means(including electronic storage and retrieval or translation into a foreign language) without prior agreement and written consent from the copyright owner.

Precautions

Thank you for your continued patronage. Observe the following precautions in order to make safe and stable use of the detector.

【 Important ! 】







Precautions are divided into three groups in this operation manual depending on the degree of danger. The three groups are

 **Warning** : This sign is used where failure to follow strictly the instructions and procedures indicated by this sign may cause injury or damage to health.

Caution : This sign is used where failure to follow strictly the instructions and procedures indicated by this sign may cause this detector and the peripheral apparatus to deteriorate or break down.

Note : This sign is used wherever information is given to ensure optimal performance of the detector.

Precautions listed below are those of particular importance extracted from this operation manual :

-  **Warning** Do not use the detector in places where combustible gas or any source of fire or of spark exists or might exist.
-  **Warning** Prior to connection, make sure that the voltage of the power socket into which the detector power cable is plugged is the same as the power supply voltage indicated on the detector.
-  **Warning** The type of the power socket into which the detector power cable is plugged should be of a 3P type with a grounding terminal. Other type of power socket should not be used.
-  **Warning** The accessory power cable should be used to connect the detector to the power socket. Other cable should not be used.
-  **Warning** When using organic solvent, wear safety goggles. It is recommended that a sink or the equipment for washing eyes be installed nearby in case the organic solvent in use comes into contact with the eye(s) or skin.
-  **Warning** When any abnormality, such as liquid leakage, is observed, turn off the power and unplug the detector from the main power source immediately.

**Warning**

Do not use the detector with the cover open; always unplug the detector from the main power source before opening the cover.

**Warning**

If the detector is used in a manner not specified by this operation manual, the protection provided by the detector may be impaired.

**Warning**

When using flammable organic solvent as mobile phase, be sure making necessary arrangement to prevent an accidental ignition (firing) by static electricity.

**Warning**

If the fuse is kept blown off after being replaced, power off the detector immediately and disconnect the power cord. Please consult out local representative in your area or SHOKO SCIENCE.

Caution

Use only the following power supply cord. Using the wrong power cord could result in danger or fire. The protection Class I equipment should be connected to PE (protective earth) terminal.

Caution

External input/output are for contact closure. Never apply voltage to those.

Caution

As this detector is readily affected by the ambient temperature, use it in places where there is little wind or change in the ambient temperature. Do not use the detector near any source of vibration, electrical noise, or in places where corrosive gas and a lot of dust exist.

Caution

Do not connect any tube other than the provided "OUT tube" to the eluent outlet joint of the detector. Put the exit end of the "OUT tube" in the waste liquid bottle and do not apply back pressure.

Caution

When connecting this detector to other detectors in series, put it at the end.

Caution

If eluent freezes inside the detector, the flow line might break damaging the detector. If there is any chance of eluent freezing during stoppage or storage of the detector, withdraw the eluent completely from the flow line of the detector.

Caution

When using any eluent containing a salt of high concentration, make sure that the flow line is washed with water thoroughly after use. Failure to do so may result in the plugging of the line causing the detector to cease operation.

- Caution** If the detector is not to be used for more than one week, then, prior to storage, wash the flow line with pure water or acetone, and dry the line by allowing nitrogen gas to flow through.
- Caution** Do not use any eluent which might corrode the material, such as stainless steel, that it comes into contact with. Use of such eluent might cause a base line drift and damage the detector.
- Caution** Use a dry cloth to wipe the detector.
Do not use water or alcohol. Use of such liquids may damage the detector or erase characters or color on the panel.
- Note** Do not connect any cord to the output signal terminal other than the attached signal cord.
- Note** Use a thoroughly degassed eluent. It is recommended that a degassing device be used to degas the eluent as it is easy to use and permits continuous degassing.
- Note** If an eluent is replaced with another eluent in which it is insoluble, after having withdrawn the old eluent from the line, wash the line with a solvent which is soluble in both eluents, then fill the line with the new eluent. For example, if water is replaced with chloroform, wash the line with acetone before filling the line with chloroform.
- Note** When replacing an eluent containing salt with an eluent containing organic solvent, wash the line with pure water and then acetone before filling the line with the organic-solvent-containing eluent. In contrast, when replacing an eluent containing organic solvent with an eluent containing salt, wash the line with acetone first and then pure water before filling the line with the salt-containing-eluent.
- Note** When high voltage cause by static electricity applies to the instrument, there are possibilities some incorrect actions are observed. Please notice the static electricity.
- Note** Please do not set other equipments on this detector because of avoiding enlarging the baseline drift and uncontrolling temperature.

Contents

1 . Accessories	1
2 . Features	2
3 . Specifications	3
4 . Detection Principle	4
4-1 Optical System	4
4-2 Flow Line	5
4-3 Electric Circuit	6
5 . Nomenclature and Function	8
5-1 Front Panel	8
5-2 Side Panel	9
5-3 Back Panel	10
5-4 Display	11
5-5 Start-Up Sequence	15
6 . Installation and Connection	16
6-1 Power Connection and Grounding	16
6-2 Signal cable Connections	17
6-3 Tube Connections	18
6-4 Operation Procedures	19
7 . Care And Maintenance	21
7-1 Flow Line Cleaning	21
7-2 Replacing Fuse	21
7-3 Cleaning of detector exterior	21
8 . Validation	22
9 . Troubleshooting	24
10. WEEE Instructions	26
Appendix 1 「Property Data of Solvents」	27
Appendix 2 「Components and Subassemblies」	28

1. Accessories

When unpacking, please check if all the following accessories are contained:

【 Details of Accessories 】

No.	Name	Specification	Quantity
1	Power cable	(1) Voltage is 100 or 120 V AC Power supply cable set (125V) (2) Voltage is 220 or 240 V AC Power supply cable set (250V)	1*
2	Signal cable	2-core shield cable (approx. 2m)	1
3	IN tube set	Stainless steel tube of 1.6 mm outer dia. x 0.18mm inner dia. x 500 mmLength (setscrew and ferrule attached)	1
4	OUT tube set	Teflon tube of 2.5 mm outer dia. x 1.5 mm inner dia. x 2000 mmLength (connecting tube, setscrew and ferrule attached)	1
5	Discharge tube set	Silicone rubber tube of 10 mm outer dia. x 7 mm inner dia. x 2000 mmLength (connection joint attached)	1
6	Fuse	Time-lag type 3.15 A (T3.15A/250V)	2
7	Operation manual		1

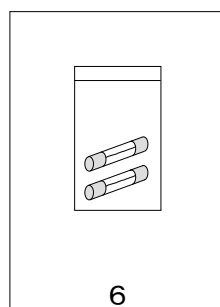
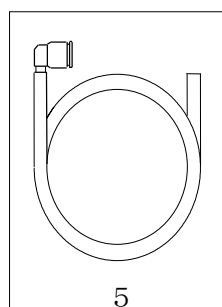
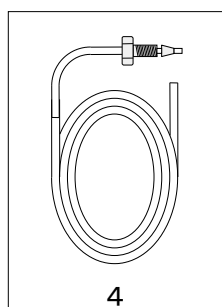
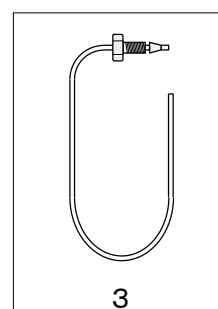
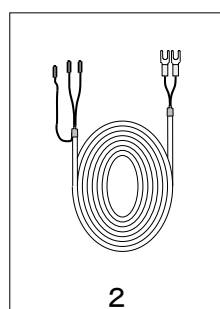
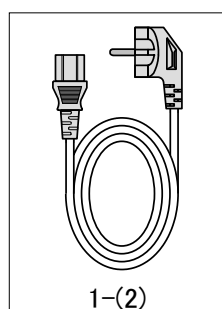
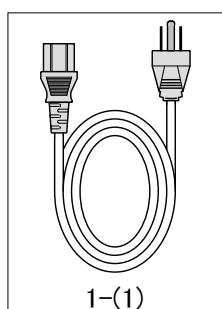

* : Either 1-(1) or 1-(2) is attached according to the power supply voltage at the first destination.

2. Features

Shodex RI-504 is Deflection Type Refractive Index Detector with following features:

1) Stability

The **double temperature control system** provides for a very fast start up time and excellent stable baseline performance.

2) Safety

Solvent leak sensor generates an output signal that stops pump flow in case of an eluent leak within the detector.

Relief valve provided in the flow path, to prevent damage such as a solenoid valve by overpressure.

3) Integration

As well as an LAN communication port, the detector is fitted with signal input and output terminals, which permit highly automated operation when combined with HPLC system.

3. Specifications

- 1) Construction : Deflection type
- 2) Refractive Index Range : 1.00 ~ 1.75
- 3) Range : 0.25 ~ 512 μ RIU
- 4) Linearity : 600 μ RIU
- 5) Noise : 5 nRIU or less (Response : 1.5 seconds)
- 6) Drift : 200 nRIU/h or less (Pure water 1mL/min, Purge OFF)
- 7) Response Time : 0.1 , 0.25 , 0.5 , 1.0 , 1.5 , 2 , 3 , 6 sec.
- 8) Auto Zero : Full automatic (Optical & Electrical Auto-Zero)
- 9) Base line shift : Range; 0 ~ 10000 nRIU, Resolution; 50 nRIU
- 10) Integrator Output : 0 ~ 1 V/FS (Sensitivity : 2 mV/ μ RIU , 8 mV/ μ RIU)
- 11) Recorder Output : 0 ~ 10 mV/FS
- 12) External Signal Input : Auto Zero , Purge On / Off
(Contact Capacity : DC24V 0.1A min.)
- 13) External Signal Output : (1) Ready (Temperature control stable)
(2) Solvent Leak
(3) Error (One of following error occurred)
HOME POSITION , OVER HEAT
INTENSITY, TEMP.ERROR
(Contact Capacity : DC24V 0.1A max.)
- 14) Temperature Control : OFF , 30 ~ 55 °C (1°C increment) : 77°C Temp. FUSE
(Note) External temperature control is set to a temperature
5°C lower than the set temperature.
- 15) Operator Support : Automatic Start Up (Start Up Sequence)
Span / Validation Guide
- 16) External Communication : LAN
- 17) Cell Volume : 2.5 μ L
- 18) Maximum Flow Rate : 1 mL/min (mobile phase : pure water)
- 19) Pressure Rating : 50 kPa (0.5kgf/cm²)
- 20) Internal Volume : Inlet Port / Flow Cell : approx. 10 μ L
Flow Cell / Outlet Port : approx. 385 μ L
Total : 400 μ L
- 21) Wetted Material : SUS316 , Teflon , Quarts Glass
- 22) AC Power Source : AC 100 – 240 V , 50 / 60 Hz , 150 VA (maximum)
Voltage fluctuation: \pm 10% , Protection Class: Class I
- 23) Installation Conditions : Operating Environmental Conditions
Temperature : 10 ~ 30°C)
Humidity : 90%RH (Non-condensing)
Altitude : 2000m (maximum)
Pollution : Degree 2
Installation : Category II
- 24) Dimensions : 260 mm(W) x 165 mm(H) x 420 mm(D)
- 25) Weight : Approx. 12.5 kgs (28lbs)
- 26) Conforming Standards : CE marking
EMC Directive (2004/108/EC)
Low Voltage Directive (2006/95/EC)
RoHS Directive (2011/65/EU)

4. Detection Principle

4-1 Optical System

In a refractive index detector of the deflection type, the light beam undergoes a deflection in proportion to a difference in refractive index between one liquid and the other as it passes through the two compartments of the flow cell, each being filled with a different liquid. The deflection of the light beam is taken as a displacement on the light-receiving element and is displayed as a difference of the refractive index.

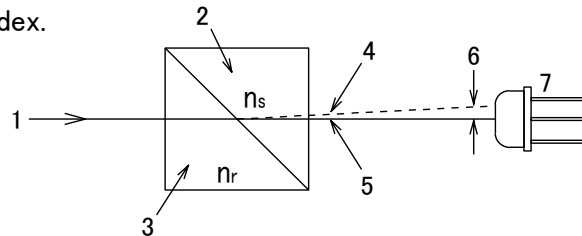

- | | |
|---|--|
| 1 : Light beam | n_s : Refractive index of liquid in sample cell |
| 2 : Sample cell | |
| 3 : Reference cell | |
| 4 : Light beam at the time of $n_s > n_r$, | n_r : Refractive index of liquid in reference cell |
| 5 : Light beam at the time of $n_s = n_r$, | |
| 6 : Displacement | |
| 7 : Light-receiving element | |

Fig. 4.1 Principle of detection of the deflection type

A variety of ingenious devices are provided in the optical system to enhance its operational stability and make the detector more compact. The light beam from the light source passes the flow cell through condenser lens, slit No.1, collimator lens and slit No.2. The light is reflected by the mirror which exists just behind the flow cell and it forms an image of slit No.1 onto the photo sensor through the flow cell, slit No.2, collimator lens and null glass. The photo sensor has two light receivers placed side by side.

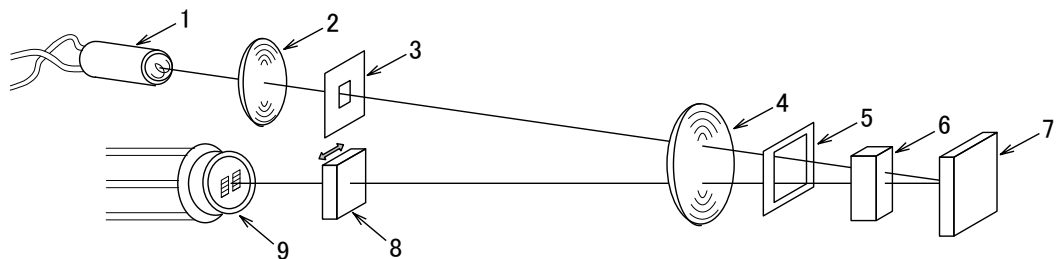

- | | | |
|--------------------|---------------------|------------------|
| 1 : Light source | 4 : Collimator lens | 7 : Mirror |
| 2 : Condenser lens | 5 : Slit No.2 | 8 : Null glass |
| 3 : Slit No.1 | 6 : Flow cell | 9 : Photo sensor |

Fig. 4.2 Optical System

When a difference develops in the refractive index between the sample and the Reference in the flow cell, the image on the photo sensor moves horizontally as illustrated in Fig. 4.3 below (moves from (a) to (b)). The electric signals emitted respectively from the photo sensor change in proportion to the extent of movement of the image.

Thus, signal corresponding to the difference in refractive index can be obtained from a difference between the two signal outputs.

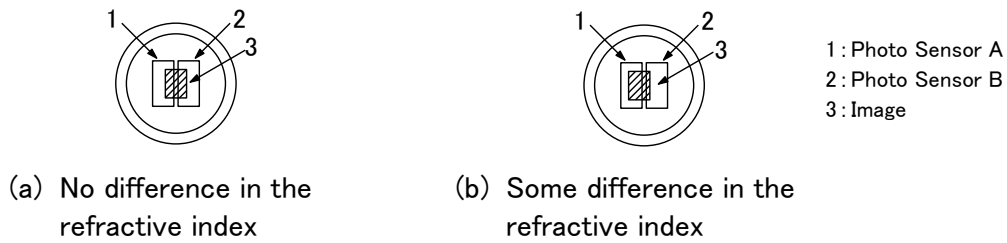

Fig. 4.3 Movement of the image on the photo sensor

4-2 Flow Line

As shown in Fig 4.4 below, the flow line is so designed as to enable replacement of a reference liquid by only pushing a button.

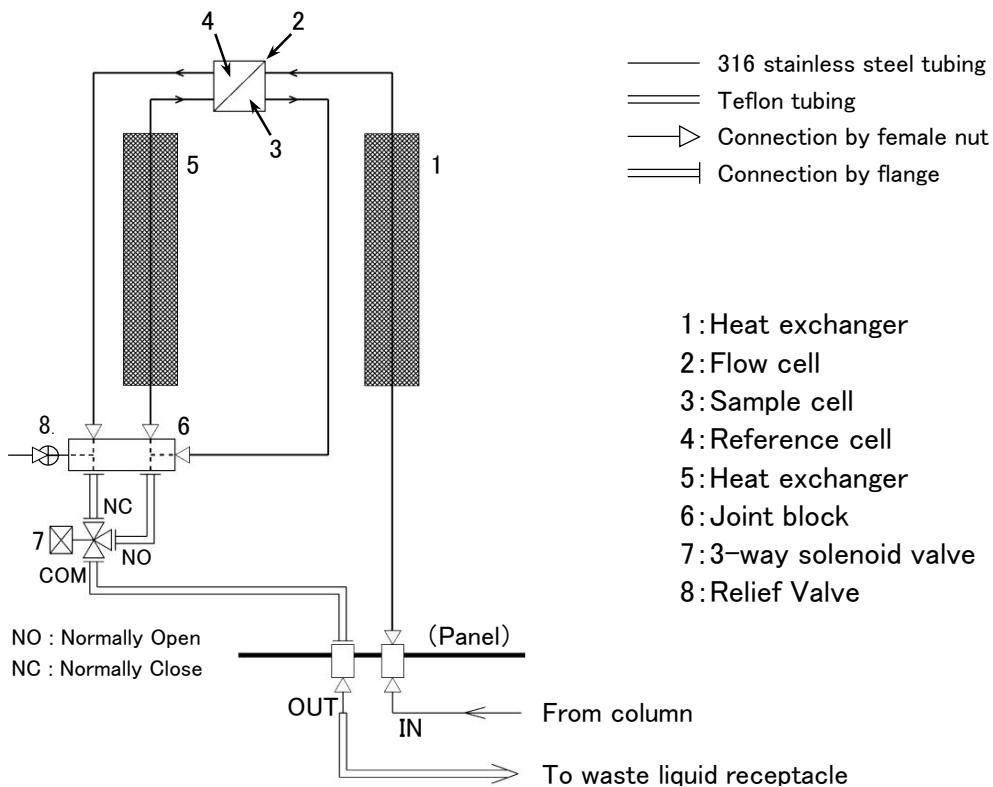

Fig. 4.4 Flow Line

When the PURGE button (solenoid valve) is in the ON position, NC is open and NO is closed, thereby allowing an eluent to flow out of the sample cell to the waste liquid receptacle by way of the reference cell.

When the button is in the OFF position, NC is closed and NO is open, thereby allowing the eluent to flow from the sample cell directly to the waste liquid receptacle without going through the reference cell.

When the pressure in the flow path has become excessive, relief valve will reduce the pressure.

4-3 Electric Circuit

The electrical circuit of **Shodex** RI-504 consists of two I/V converters, a signal processing circuit (with display and keyboard), a temperature control circuit and a light intensity control circuit.

The temperature control circuit and light intensity control circuit are controlled by the signal processing circuit.

Fig. 4.5 shows electrical system block diagram of the RI-504.

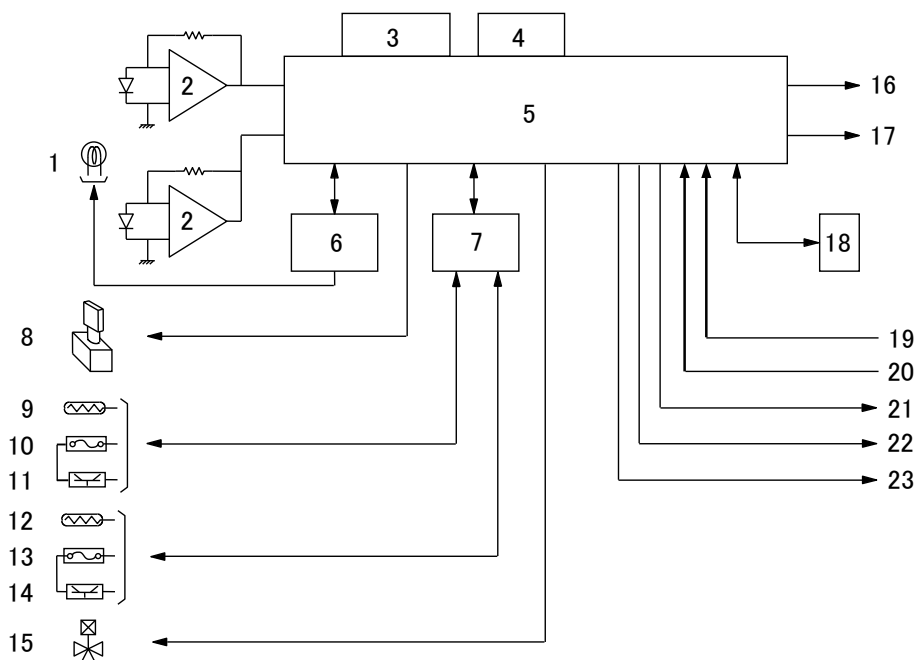

- | | | |
|-------------------------------------|------------------------------------|----------------------------|
| 1 : Light source | 9 : Temperature sensor (internal) | 17 : Recorder Output |
| 2 : I/V converters | 10 : Temperature fuse (internal) | 18 : LAN port |
| 3 : Keyboard | 11 : Heating element (internal) | 19 : Signal In (Purge) |
| 4 : Display | 12 : Temperature sensor (external) | 20 : Signal In (Zero) |
| 5 : Signal Processing circuit | 13 : Temperature fuse (external) | 21 : Signal Out (Ready) |
| 6 : Light Intensity Control circuit | 14 : Heating element (external) | 22 : Signal Out (Leak Out) |
| 7 : Temperature Control circuit | 15 : Solenoid Valve | 23 : Signal Out (Error) |
| 8 : Null glass driver | 16 : Integrator Output | |

Fig. 4.5 Electrical System

Two photo sensing elements generate a photocurrent proportional to the amount of light. These currents are then converted to the voltage signal in the I/V converters. These voltage signals will then be sent to the signal processing circuit where their Balance will be precisely converted into the digital signal corresponding to the refractive index.

This digital signal will go through (1) Sensitivity calculation, (2) Response time calculation, (3) Auto Zero / Base line shift calculation, (4) Range attenuation for recorder output and (5) Event Marker processing in that order and will finally be converted back to analog signal for integrator output terminal and recorder output terminal.

The signal processing circuit does also following jobs:

- ① Parameter settings via Display or Keyboard (Recorder Range, Integrator Sensitivity, Temperature Control, Response Time, Polarity, Base Line Shift).
- ② Commands requested via Keyboard (Purge On / Off, Event Marker and Auto Zero : Optical Auto Zero is carried out by activation of the null Glass driver and fine adjustments are made through calculation).
- ③ Execution of commands given via external device (e.g. purge on / off, auto zero).
- ④ Displaying data and status information such as Refractive Index, Temperature.
- ⑤ Signal outputs (displays various error messages such as Temperature control, Light Intensity control, Auto Zero and contact closure signal for output terminals).
- ⑥ Data display and setting for maintenance.
- ⑦ LAN communication processing.

Light Intensity Control circuit controls a load current to the light source to keep intensity signal (sum of the two I/V converters output voltage) constant.

This feature prevents unexpected reductions in detector sensitivity due to such problems as dirty flow cells, decreased lamp intensity.









Based on the data from temperature sensors of the optical system and the external heater plate, the temperature control circuit adjusts the current in the heating elements (transistors) so that the temperatures of the optical system and the external heater plate reach their designated values.











5. Nomenclature and Function

5-1 Front Panel



Fig. 5.1 Front panel of **Shodex** RI-504

No.	Name of parts	Function
1	Power Switch	Press this key once to turn on or off the unit.
2	LCD Display	A 24-digit 2-row character display panel. This is used for displaying or setting various parameters.
3	Start Up Sequence key 	Press the  key once to call the start-up sequence.
4	Purge Key 	Press the  key to turn the purge valve on or off to change the flow path. When the valve is on, the LED above the key will be lit and the eluent will flow through the reference cell chambers. Press  to turn off the valve.
5	Marker key 	Press  key to generate an event marker signal and add it to the recorder output. During this function, the LED above the key will be lit.
6	Leak LED [Leak]	Illuminated when solvent leak is detected.
7	Auto Zero Key 	Press the  key to activate "Auto-Zero". During this function, the LED above the key will be lit.

No.	Name of parts	Function
8	ESC Key 	Press the  key to cancel an operation and return to the normal screen.
9	Arrow Keys    	Press Arrow keys to move cursor or to edit values.
10	Cancel Key 	Press  key to cancel change and to stop beep.
11	Enter Key 	Press  key to finalize operations or settings.
12	Inlet Port [IN]	Connects tubing from separation column outlet.
13	Outlet Port [OUT]	Eluent passing through the flow path is discharged from this port.

5-2 Side Panel

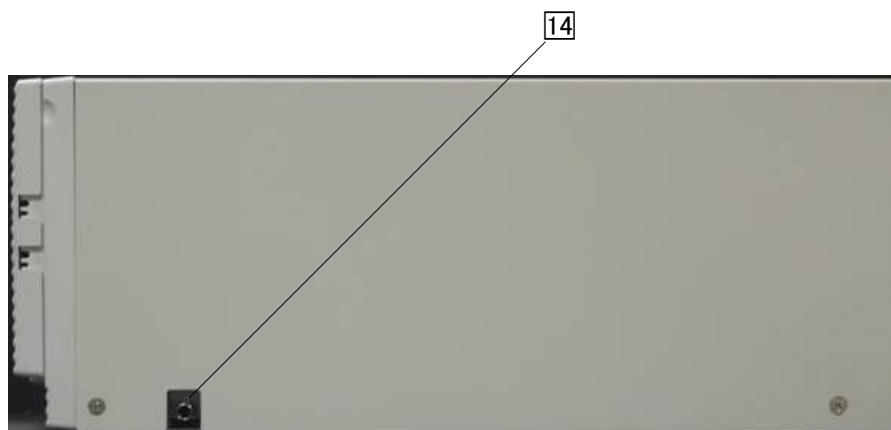

Fig. 5.2 Side panel of **Shodex** RI-504

No.	Name of parts	Function
14	Drain Port	In case of internal eluent leak, the eluent will be discharged From this port. Connect the attached tubing as necessary.

5-3 Back Panel



Fig. 5.3 Back panel of **Shodex** RI-504

No.	Name of parts	Function
15	Communication port [COM]	LAN communication port
16	Zero in terminals [ZERO IN]	When these two terminals are short-circuited just as when the zero Button (7) is pressed, the automatic zeroing is actuated.
17	Purge terminals [PURGE IN]	When these two terminals are short-circuited, the flow line of the eluent is changed just as when the purge button (4) is pressed, and both sample and reference cells are filled with the same eluent.
18	Error out terminals [ERROR OUT]	A contact signal is sent out through these terminals when an error occurs. (ROM, RAM, Parameter, Home Position, Overheating, Optical Balance, Intensity)
19	Leak out terminals [LEAK OUT]	A contact signal is sent out through these terminals when an eluent leak is detected.
20	Ready out terminals [READY OUT]	A contact signal is sent out through these terminals when 10 minutes have passed since the temperature of the optical system reached the designated value.
21	Recorder terminals [REC. OUT]	Signals to the recorder are sent out through these terminals. The sensitivity of the output signal is 10 mV/FS.
22	Ground terminal for the signal cable [FG]	The shield terminal of the signal cable should be connected to this terminal.
23	Integrator terminals [INTEG. OUT]	Signals to the data processing unit are sent out through these terminals. The sensitivity of the output signal is 2 mV/ μ RIU or 8 mV/ μ RIU with the integrator range of 512 μ RIU/V or 128 μ RIU/V, respectively.

24	Power connector [~LINE]	The included power cable should be plugged into this connector.
25	Ground terminals [⏏]	These are the terminals to ground the main body of the detector.

5-4 Display

The display shows a “Monitor screen” when the detector is started and can be Switched to a “Parameter setting screen” and “Validation screen” when the ◀ key or the ▶ key is pressed.

<Monitor screen> <Parameter setting screen> <Validation screen>

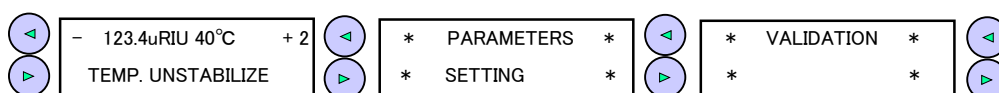

<Monitor screen>

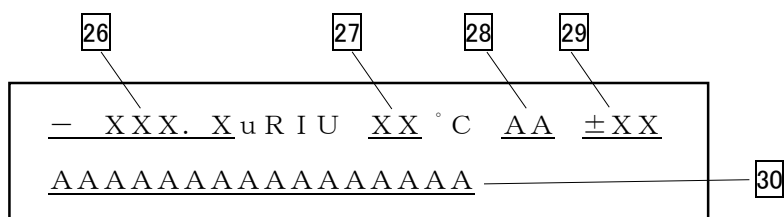

No.	Function
26	This indicates the refractive index in μ RIU unit.
27	This indicates the temperature of the optical system.
28	<p>One of the following is displayed in response to the detector status.</p> <p>(1) LK : Key Lock status (2) ER : Error status (3) RD : Analyzable state (This sign will come on when the start-up sequence is completed.)</p>
29	<p>This indicates the current state of optical axis balance in a range of -99 to +99. Press Zero key to display -3 to +3.</p>

This indicates error or operation status.

If there are multiple messages to be displayed, the priority message is displayed.

(1) ROM : Is displayed when a ROM error has occurred.

(2) RAM : Is displayed when a RAM error has occurred.

(3) PARAMETER : Is displayed when a parameter memory error has occurred.

(4) HOME POSITION : Is displayed when the optical axis is not adjusted correctly.

30 (5) LEAKAGE : Is displayed when eluent leakage has occurred.

(6) TEMP. ERROR : Is displayed when the temperature sensor has a problem.

(7) OVER HEAT : Is displayed when the temperature is excessively high.



(8) OPT. BALANCE : Is displayed when Auto Zero does not function correctly.

(9) INTENSITY : Is displayed when the light intensity is low due to bubbles or dirt.



(10) TEMP. UNSTABLE : After the detector is started, this remains displayed until the temperature remains within $\pm 1^{\circ}\text{C}$ of the set temperature for 10 minutes.

(11)Cannot set the LAN unit / Push the Enter Key : Is displayed when a LAN setting error has occurred.

<Parameter setting screen>

To show the currently set parameters in order, press the  key or the  key while the parameter setting screen is displayed.

< Validation screen >



To show the Validation screen in order, press the  key or the  key while the practice screen of each validation and the result is displayed.

To change parameters, perform the following procedures:

(1) Display the relevant parameter.

(2) Press the  key.

The underlined digits will flash and the parameter can be changed.

(3) Press the  key or the  key to change the parameter with reference to Table 5-1.

(4) Press  key to finalize the parameter.

(5) Press  key to return to the monitor screen.

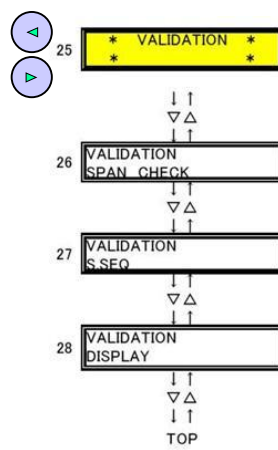
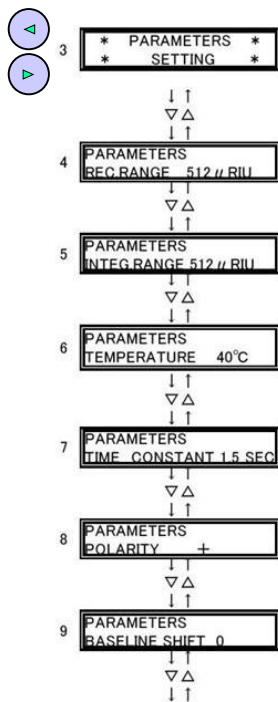
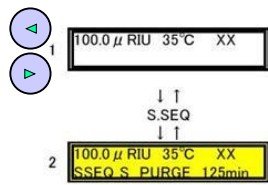

Press The Enter key to start the SPAN CHECK.

Press The S.Seq key to start and stop the S.SEQ.

Press The Enter key to display the result of the validation

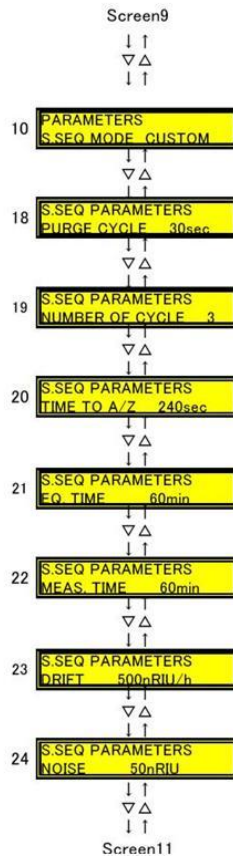
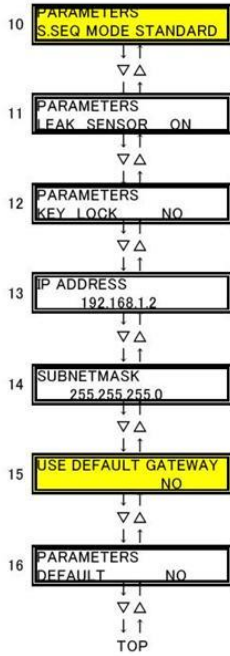
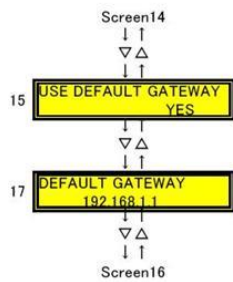

Each S.SEQ mode is changed with the ENTER key and Arrow Keys

The S.SEQ mode is displayed by a screen2.

Only in CUSTOM mode, screen 25 is displayed from screen 19

Table 5-1 Settable parameters

No.	Parameter	Selectable value	Unit	Default
1	REC. RANGE	0.25, 0.5, 1, 2, 4, 8, 16, 32, 64, 128, 256, 512 (12 Steps)	μ RIU/10mV	512
2	INTEG. RANGE	128, 512	μ RIU/1024mV	512
3	TEMPERATURE	OFF, 30~55 (1 Step)	°C	40
4	TIME CONSTANT	0.1, 0.25, 0.5, 1, 1.5, 2, 3, 6 (8 Steps)	sec	1.5
5	POLARITY	+, -	-	+
6	BASELINE SHIFT	0~200 (1 Step 50nRIU)	-	0
7	S. SEQ MODE	FINE, STANDARD, COARSE, CUSTOM	-	STANDARD
8	LEAK SENSOR	ON, OFF	-	ON
9	KEY LOCK	YES, NO	-	NO
10	IP ADDRESS	0.0.0.0 ~ 255.255.255.255	-	192.168.1.2
11	SUBNETMASK	128.0.0.0 ~ 255.255.255.254	-	255.255.255.0
12	USE DEFAULT GATEWAY	YES, NO	-	NO
13	DEFAULT GATEWAY	0.0.0.0 ~ 255.255.255.255	-	192.168.1.1
14	DEFAULT DATA	YES, NO	-	NO

5-5 Start-Up Sequence

1) S.SEQ MODE

Choose one of the built-in sequences (Fine, Standard, Coarse) from the menu or make own sequence (Custom).

Each S.SEQ mode is changed with the ENTER key and Arrow Keys

Table 5-2 Parameters (Start- Up Sequence)

No.	Parameter	FINE	STANDARD	COARSE	CUSTOM
1	Purge Cycle	30 sec			10~990 sec
		This repeatedly turns on and off the purge solenoid valve to remove air bubbles trapped in the flow cell. The term Purge Cycle is used for the length of one purge cycle. The default setting is 30 seconds. With this setting, the valve remains on for 15 seconds and off for another 15 seconds. Choose preferred setting (Custom) if necessary.			
2	Number of Cycle	3			3~9
		This sets the number of the purge cycle.			
3	Time to Auto Zero	240 sec			60~990 sec
		At the end of the purge cycles, the auto-zeroing should be made. This defines the length of the pause period between the end of the purge cycles and the auto-zeroing.			
4	Equilibration Time	80 min	60 min	40 min	12,15~300 min
		This is a period in which the detector is equilibrated for the measurement of drift and noise performance.			
5	Measuring Time	80 min	60 min	40 min	12,15~300 min
		This is a period in which drift and noise performance is measured after reaching equilibrium.			
6	Drift	100 nRIU/h	500 nRIU/h	2500 nRIU/h	50~9990 nRIU/h
		Set a target drift value here.			
7	Noise	50 nRIU			3~998 nRIU/h
		Set a target noise value here.			

6. Installation and Connection

6-1 Power Connection and Grounding

Connect the detector to the power source according to the following procedure:

- 1) Confirm that the type of the power socket into which the detector power cable is plugged is of a 3P type with a grounding terminal.
- 2) Confirm the voltage of the power socket into which the detector power cable is plugged is the same as the voltage indicated on the rear panel of the detector.
- 3) Turn off the power switch of the detector.
- 4) Connect the detector to the power source using the accessory power cable.



Prior to connection, make sure that the voltage of the power socket into which the detector power cable is plugged is the same as the power supply voltage indicated on the detector.



The type of the power socket into which the detector power cable is plugged should be of a 3P type with a grounding terminal. Other type of power socket should not be used.



The accessory power cable should be used to connect the detector to the power socket. Other cable should not be used.



Do not use the detector in places where combustible gas or any source of fire or of spark exists or might exist.



As the detector is readily affected by the ambient temperature, use it in places where there is little wind or change in the ambient temperature. Do not use the detector near any source of vibration, electrical noise or in places where corrosive gas and a lot of dust exist.



Please do not set other equipments on this detector because of avoiding enlarging the baseline drift and uncontrolling the temperature.

6-2 Signal cable Connections

Make correct connections using the provided signal cables in accordance with the figures below.

Connect red wire to "+" terminal, white wire to "-" terminal and clear wire to "FG".

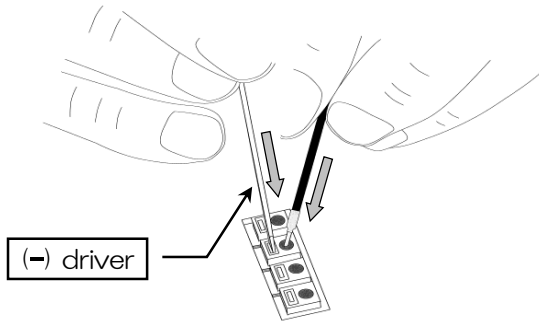

Inserts the end of lead wire while pressing the button with (-) driver.

<connect the wire>

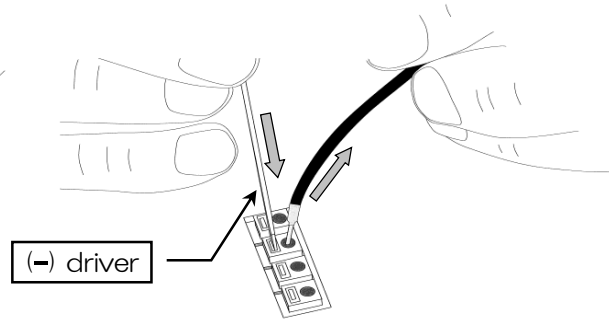

Then, remove the (-) driver to lock the wire. Make sure the wire is firmly grabbed.

<disconnect the wire>

For the contact signal out (Ready, Solvent Leak, and Error) cable connection, please use duplex lead wire.

Caution

External input/output (Auto Zero-In, Purge-In, Ready-Out, Leak-Out, and Error-Out) are for contact closure. Never apply voltage to those.

6-3 Tube Connections

When connecting this detector to a high performance liquid chromatograph through tubes, wash the chromatograph and columns thoroughly with the eluent in use and make sure that the eluent is clean before connecting the tube.

Connect the tubes in accordance with the following procedures :

- 1) Connect the eluent inlet joint **13** to the outlet of the column to be used through the provided IN TUBE.
When fastening the stainless steel set screw of the IN TUBE, grip the eluent inlet joint **13** with a spanner.
- 2) Connect the supplied OUT TUBE to the eluent outlet joint **12** .

Caution *Do not connect any tube other than the provided OUT TUBE to the Eluent outlet joint **12** of the detector.
Put the exit end of the OUT TUBE in a waste liquid receptacle and do not apply back pressure.*

Caution *When connecting this detector to other detectors in series, connect this detector at the end.*

6-4 Operation Procedures

Use the detector in accordance with the following procedures:

[Automatic Start up]

- 1) Set parameters on the operating parameter-setting screen.
- 2) Set parameters on the start-up sequence parameter-setting screen.
- 3) Start pumping the eluent at a flow rate of 1 mL/min.
If pumping can be done only at a flow rate lower than 1 mL/min, a longer purge cycle needs to be set.
- 4) Press the **S.Seq** key once to call the start-up sequence.
The time elapsed from the sequence start and the total sequence time are displayed on the screen.
- 8) If the drift or noise meets the target value within the defined period (Measuring Time), a message (“GOOD”) will appear in the Monitor screen.
- 9) When the **S.Seq** key is pushed, “Measuring Time” will be repeated.
When the **ESC** key is pushed, the measurement results will be disregarded and the start-up sequence finished.
Though the **RD** sign does not come up, the detector is ready for analysis.
- 10) As soon as the drift and noise meet the target values during “Measuring Time” the sequence is complete and the **RD** sign will come up on the Monitor screen.

[Manual Start]

- 1) Set the parameter on operating parameter-setting screen (Refer to 5-4).
- 2) Start pumping mobile phase solvent at flow rate 1 mL/min to reference cell (Purge On).
- 3) Press **Purge** key in every 10 seconds to on/off the purge valve for few minutes.
- 4) Keep pumping mobile phase solvent to reference cell for about 20 minutes from the above step 2).
- 5) Press **Purge** key to turn off the valve. Mobile phase solvent flows to sample cell.
- 6) Wait until the baseline is stabilized.
- 7) Press **Zero** key to do Auto Zero.



Warning

*When using organic solvent, wear safety goggles.
It is recommended that a sink or the equipment for washing eyes be installed nearby in case the organic solvent in use comes into contact with the eye(s) or skin.*



Warning

*When any abnormality, such as liquid leakage, is observed, turn off the power immediately.
Unplug the detector from the main power source before opening the cover.*



Warning

When using flammable organic solvent as mobile phase, be sure making necessary arrangement to prevent an accidental ignition (firing) by static electricity.

- Caution** *If any eluent freezes inside the detector, the flow line might break damaging the detector. If there is any chance of the eluent freezing during stoppage or storage of the detector, withdraw the eluent completely from the flow line of the detector.*
- Caution** *When using any eluent containing a salt of high concentration, make sure that the flow line is washed with water thoroughly after use. Failure to do so may result in the plugging of the line causing the detector to cease operation.*
- Caution** *If the detector is not to be used for more than one week, then, prior to storage, wash the flow line with pure water and acetone, and dry the line by allowing nitrogen gas to flow through.*
- Caution** *Do not use any eluent, including hydrochloric acid, which might corrode the material, such as stainless steel, that it comes into contact with. Use of such eluent might cause a base line drift and damage the detector.*
- Caution** *A Waste liquid bottle, please be installed at the same height as the detector . If place a waste liquid bottle on the floor, it will be the cause of occurrence and intensity error of the bubble.*
- Note** *Use a thoroughly degassed eluent. It is recommended that a degassing device be used to degas the eluent as it is easy to use and permits continuous degassing.*
- Note** *If an eluent is replaced with another eluent in which it is insoluble, after having withdrawn the old eluent from the line, wash the line with a solvent which is soluble in both eluents, then fill the line with the new eluent. For example, if water is replaced with chloroform, wash the line with acetone before filling the line with chloroform.*
- Note** *When replacing an eluent containing salt with an eluent containing organic solvent, wash the line with pure water and then acetone before filling the line with the organic-solvent-containing eluent. In contrast, when replacing an eluent containing organic solvent with an eluent containing salt, wash the line with acetone first and then pure water before filling the line with the salt-containing-eluent.*

7. Maintenance

7-1 Flow Line Cleaning

Depends on the solvents in use, the cleaning procedure is varied. Following is a procedure for typical.

- 1) Inject cleaning solution (acetone) by syringe from the inlet port (5 mL).
- 2) Inject deionized water by syringe from the inlet port (5 mL).
- 3) Exchange deionized water with the mobile phase solvent.

If buffers or solutions of high salt content have been in use, the cells may be contaminated by precipitated salt. Large amounts of distilled, deionized water, such as 1 mL/min, for up to several hours, is the simplest clean-up procedure.

7-2 Replacing Fuse

When the fuse is blown, replace the following procedures:

- 1) Turn off the power of detector.
- 2) Remove the power cord.
- 3) Remove the blown fuses.
- 4) Replace new fuses.

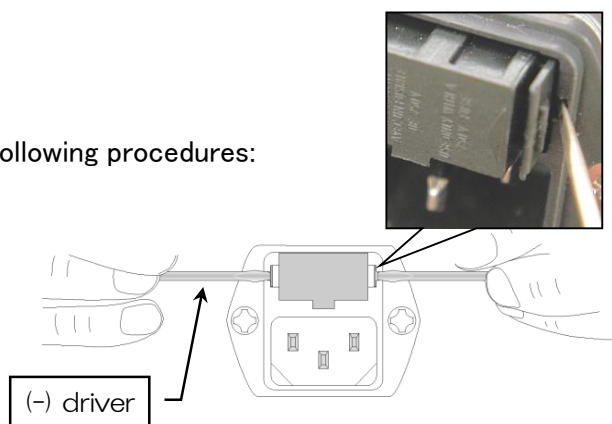

Replace only with same type and rating of fuse.

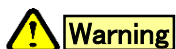

Warning

If the fuse is kept blown off after being replaced, power off the detector immediately and disconnect the power cord.



Warning

Please consult our local representative in your area or SHOKO SCIENCE CO.,LTD.

7-3 Cleaning of detector exterior

When the exterior such as top cover of front panel were stained or got wet for whatever reasons, please keep the detector clean and dry by wiping off it by soft cloths or tissue paper. If stains are hard to remove, try soft cloths absorbed a weak water solution of kitchen detergent.

Caution

Use a dry cloth to wipe the detector. Do not use water or alcohol. Use of such liquids may damage the detector or erase characters or color on the panel.

Caution

If the detector is not to be used for more than one week, then, prior to storage, wash the flow line with pure water and acetone, and dry the line by allowing nitrogen gas to flow through.

8. Validation

It is recommended that the HPLC system be validated from time to time to maintain the accuracy and reliability of analysis. This task of validation has been made easier due to the unique and user-friendly feature of **Shodex RI-504**.

SPAN CHECK		Press the Enter key to obtain the "SPAN VALIDATION" screen. (Refer to the following for the details.)
S.SEQ		Press the S.Seq key once to call the start-up sequence. The sequence is complete and the sign (RD or "FAIL") will come up on the Monitor screen.
DISPLAY	TEMPERATURE	This indicates the difference between the set temperature and the actual temperature in degree Celsius. When the difference becomes within "+ or -" 1 degree, a message("GOOD") will appear in the Monitor screen.
	LAMP VOLTAGE	This indicates the voltage applied to the lamp. When the Voltage falls 4.9V, a message("GOOD") will appear in the screen.
	DRIFT	This indicates a result of "S.SEQ" . When the drift falls set value, a message("GOOD") will appear in the screen.
	NOISE	This indicates a result of "S.SEQ" . When the noise falls set value, a message("GOOD") will appear in the screen.
	SPAN	This indicates a result of "SPAN CHECK" . Please check whether the display value is "487-537" μ RIU.

Do the Span Validation, follow the procedures below :

1) Preparation of standard sucrose solution :

Weigh 350 mg of sucrose and transfer it to a 100 mL volumetric flask.
Dissolve it with deionized, filtered, degassed water until the solution reaches the mark on the flask.

Note Always use freshly made sucrose solution.

- 2) Equilibrate Shodex RI-504 by pumping deionized water through the reference and sample cells. Use the same deionized water as that used to prepare the sucrose standard solution. Start pumping at a flow rate of 1mL/min and do the start-up sequence.
- 3) Make sure that the baseline is stabilized and the drift is equal to or less than 500 nRIU/h.
- 4) Press the **Zero** key to actuate the auto-zeroing.
- 5) Press the **Enter** key to move the zero-measurement screen. and press the **Enter** key to memorize the original (0 μ RIU) baseline. The screen will move to the sample-measurement screen automatically after storing the original baseline information.
- 6) Disconnect and remove the tube from the inlet port of the detector.
- 7) Make sure that the purge valve is turned off.
- 8) Fill a syringe with the standard sucrose solution and gently inject the solution through the inlet port.
- 9) When the baseline stabilizes, press the **Enter** key to measure.
- 10) Press the **Enter** key to commit to memory.
- 11) The measurement result will come up on the validation screen.
- 12) The result should be between 487 and 537 (512 μ RIU \pm 5%).

9. Troubleshooting

If any abnormality occurs, try to solve the problem in accordance with the Instructions below.

Should the problem not be corrected even after taking the corrective actions below, contact the agent from whom you purchased the detector.

Problem	Possible cause	Solution
No power (Lamps and displays do not go on when the power button is turned on.)	<ol style="list-style-type: none"> 1. Power cable is not connected. 2. Fuse is blown. 	<ol style="list-style-type: none"> 1. Connect power cable to power socket. 2. Replace fuse. (If new fuse blows soon after replacement, contact agent for repair.)
Baseline becomes jagged.	Bubbles are present in flow cell.	<p>Pass thoroughly degassed eluent through at flow rate of about 1 mL/min. While pushing the Purge key repeatedly into ON and OFF positions for sufficient period of time (until the baseline stabilizes).</p> <p>If an aqueous eluent is in use and the baseline does not stabilize even after passing the degassed eluent for more than one hour, it will be effective to perform one passage of methanol.</p>
Periodic noises are generated.	<ol style="list-style-type: none"> 1. Pulsation by pump is large. 2. Existence of bubbles in the flow cell enlarges the pulsation by pump. 	<ol style="list-style-type: none"> 1. Install device, such as damper and resistance pipe to eliminate pulsation, close to delivery side of pump. 2. Pass thoroughly degassed eluent through at flow rate of about 1 mL/min. While pushing the Purge key repeatedly into ON and OFF positions for sufficient period of time (until the baseline stabilizes). If an aqueous eluent is in use and the baseline does not stabilize even after passing the degassed eluent for more than one hour, it will be effective to perform one passage of methanol.
No periodic noises are generated.	<ol style="list-style-type: none"> 1. Insufficient degassing 2. Flow cell is contaminated. 3. Salts separated in the tubing or flow cell. 4. Column is contaminated. 	<ol style="list-style-type: none"> 1. Pass thoroughly degassed eluent. 2. Refer to “ 7-1 flow line cleaning ”. 3. Set Purge key on and pump sufficient amount of eluent that dissolves the salts and wash with water. 4. Wash the column or use a new column.

Problem	Possible cause	Solution
Large baseline drift	<ol style="list-style-type: none">1. Insufficient solvent replacement.2. Room temperature fluctuates greatly.3. Bubbles are present in flow cell.4. Flow line is contaminated.	<ol style="list-style-type: none">1. Replace the solvent thoroughly. (Refer to the notes in 6-4.)2. Use detector in places where changes in room temperature are small.3. Pass thoroughly degassed eluent through to purge bubbles.4. Wash flow line thoroughly.

10. WEEE Instruction

WEEE Mark



Instrument marked with this mark indicates that it was sold on or after 13th August 2005, and it is covered by Waste Electrical and Electronic Equipment (WEEE) Directive.

This WEEE mark means it must be collected separately from general household waste, according to the regulatory guideline in your area. Please note that our instrument is for industrial / professional use only.

Please contact your Shodex office or Shodex distributor when the instrument has reached the end of its life. They will advise you regarding the instrument treatment.

The objective of this WEEE program are to preserve, protect and improve the quality of the environment, protect human health, and utilize natural resources prudently and rationally.

With your co-operation we are aiming to reduce contamination from waste instrument and preserve natural resource through re-use and recycling.

Please contact Shodex at the web site listed below.

<http://www.Shodex.com/support/weee.html>

Appendix 1

Property Data of Solvents

	Polarity E ² (Al ₂ O ₃)	Viscosity (cP20°C)	Refractive Index	UV Cut-off (nm)	Flash Point (°C)	Fire Point			Vapor Density	Boiling Point (°C)	Gravity
						(°C)	Lower	Upper			
Fluoroalkanes	-0.25		1.25								
n-Pentane	0.00	0.23	1.358	210	<-40	308.9	1.5	7.8	2.5	36.1	0.6
Hexane	0.00		1.375	210	-21.7	233.9	1.2	7.5	3.0	68.9	0.7
Isooctane	0.01		1.404	210							
Petroleum ether	0.01	0.3		210							
n-Decane	0.04	0.92	1.412		46.1	207.8	0.8	5.4	4.9	173.9	0.7
Cyclohexane	0.04	1.00	1.427	210	-20	260	1.3	8.0	2.9	81.7	0.8
Cyclopentane	0.05	0.47	1.406	210							
Diisobutylene	0.06		1.411	210							
i-Pentene	0.08		1.371		-17.8	272.8	1.5	8.7	2.4	30	0.7
Carbon disulfide	0.15	0.37	1.626	380	-30	100	1.3	44	2.6	46.1	1.3
Carbon tetrachloride	0.18	0.97	1.466	265							
Amyl chloride	0.26	0.43	1.413	225	12.8	343.3	1.6	8.6	3.7	106.1	0.9
Butyl chloride	0.26		1.436	220	-9.4	460	1.8	10.1	3.2		0.9
Xylene					o-17.2	463.9	1.0	6.0		144.4	
	0.26				290	m-25	527.8	1.1	7.0	3.7	138.9
					p-25	528.9	1.1	7.0		138.3	
i-Propyl ether	0.28	0.37	1.368	220	-27.8	443.3	1.4	21	3.5	68.9	0.7
i-Propyl chloride	0.29	0.33	1.378	225	-32.2	593.3	2.8	10.7	2.7	35	0.9
Toluene	0.29	0.59	1.496	285	4.4	536.1	1.4	6.7	3.1	110.6	0.9
n-Propyl chloride	0.30	0.35	1.389	225	<-17.8		2.6	11.1	2.7	46.1	0.9
Chlorobenzene	0.30	0.80	1.525		32.2	637.8	1.3	7.1	3.9	132.2	1.1
Benzene	0.32	0.65	1.501	280	-11.1	562.2	1.4	7.1	2.8	80	0.9
Ethyl bromide	0.37		1.424			511.1	6.7	11.3	3.8	37.8	1.4
Ethyl ether	0.38	0.23	1.353	220	-45	180	1.9	48	2.6	35	0.7
Ethyl sulfide	0.38	0.45	1.442	290							
Chloroform	0.40	0.57	1.443	245							
Methylene chloride	0.42	0.44	1.424	245	-50	518.9	3.8	15.4	2.2	38.5	0.9
Methyl i-butyl ketone	0.43		1.394	330							
Tetrahydrofuran	0.45		1.408	220	-14.4	321.1	2.0	11.8	2.5	66.1	0.9
Ethylene dichloride	0.49	0.79	1.445	230	13.3	412.3	6.2	16	3.4	83.9	1.3
Methyl ethyl ketone	0.51		1.381	330	-6.1	515.6	1.8	10	2.5	80	0.8
i-Nitropropane	0.53		1.400	380	48.9	420.6	2.6		3.1	131.1	1.0
Acetone	0.56	0.32	1.359	220	-17.8	537.8	2.6	12.8	2.0	56.7	0.8
Dioxane	0.56	1.54	1.422	260	12.2	180	2.0	22	3.0	101.1	1.0
Ethyl acetate	0.58	0.45	1.370	260	4.4	460	1.8	8	3.5	90	0.9
Methyl acetate	0.60	0.37	1.362	210	-10	501.7	3.1	16	2.6	60	0.9
Amyl alcohol	0.61	4.1	1.410		32.8	300	1.2	10.0	3.0	137.8	0.8
Dimethyl sulfoxide	0.62	2.24									
Aniline	0.62	4.4	1.586		70	617.2	1.3		3.2	184.4	1.0
Dimethyl amine	0.63	0.38	1.387	275	<-17.8	312.2	1.8	10.1	2.5	56.7	0.7
Nitromethane	0.64	0.67	1.394	380	35	418.3	7.3		2.1	101.1	1.1
Acetonitrile	0.65	0.37	1.344	210	5.6				1.4	81.7	0.8
Pyridine	0.71	0.94	1.510	305	20		1.8	12.4	2.7	115	1.0
Butyl cellosolve	0.74			220							
i-Propanol n-Propanol	0.82	2.3	1.38	210	11.7	398.9	2.0	12	2.1	82.8	0.8
Ethanol	0.88	1.20	1.361	210	12.8	422.8	4.3	19	1.6	78.3	0.8
Methanol	0.95	0.60	1.329	210	11.1	463.9	7.3	36	1.1	63.9	0.8
Ethylene glycol	1.11	19.9	1.427	210	111.1	412.8	3.2			197.2	1.1
Acetic acid	大	1.26	1.372								
Water	大		1.333								

* L. R. Snyder. Dekker. 「Principles of Adsorption Chromatography」

Those in should not be employed



Appendix 2

Shodex RI-504 Components and Subassemblies

<i>Part Number</i>	<i>Item / Description</i>	
SD101100	Solenoid Valve assembly	
SD101530	Flow Cell assembly	
SD101310	Internal tubing set	
SD101610	Inlet Port (Bulkhead Union)	
SD101710	Outlet Port (Bulkhead Union)	
SD100900	Lamp assembly	
SD122800	Motor assembly	
SD122810	Limit switch assembly	
SD122900	Photo sensor assembly	
SD122000	Heater set (Internal)	
SD122010	Heater set (External)	
SD122230	I/V circuit board	
SD123000	Leak sensor board	
SD122310	Measurement board	
SD122410	Front Panel	
SD122420	Joint Panel Cover	
SD122430	Power Switch key	
SD122440	LCD unit	
SD122450	Key board	
SD122460	Membrane Key sheet	
SD122600	Switching Regulator	
SD100100	Power cable (125V)	
SD100110	Power cable (250V)	
SD120200	Fuse	
SD120300	Signal cable	
SD100425	IN tube set (S)	
SD100500	OUT tube set	
SD123100	Drain tube set	
SD120070	Accessory kit (S 125V)	Power cable (125V)
		Signal cable
		Fuse
		IN tube set (S)
		OUT tube set
		Drain tube set
SD120075	Accessory kit (S 250V)	Power cable (250V)
		Signal cable
		Fuse
		IN tube set (S)
		OUT tube set
		Drain tube set

Notice

Users of **Shodex** RI-504 Refractive Index Detector are requested to use it in strict accordance with the instructions in this manual.

Nothing contained in this manual shall be construed as giving any guarantee on **Shodex** RI-504 Refractive Index Detector or granting or implying any license or immunity under any patent or other rights.

Shodex RI-504 Refractive Index Detector must be used on user's own responsibility and in strict compliance with all applicable laws and regulations.

The information contained in this manual was obtained from sources which we believe are reliable, but no warranty or representation is hereby given as to its accuracy or completeness.

Shodex RI-504 Refractive Index Detector should only be used for Liquid chromatography analysis. Do not use it for any other purpose.

This manual does not expect **Shodex** RI-504 Refractive Index Detector to be used for clinical or medical purposes. **Shodex** RI-504 Refractive Index Detector must not be used for such purposes.

The content of this manual is subject to change without notice.

Warranty

Except for a written warranty signed by its duly authorized representative and issued particularly, **SHOKO SCIENCE CO.,LTD.** makes no warranty, express or implied, written or oral, statutory or otherwise, as to the quality, performance, workmanship, fitness for a particular purpose, or merchantability of **Shodex** RI-504.



SHOKO SCIENCE CO., LTD.

Factory Department

1-3-3, Azamino-Minami, Aoba-ku, Yokohama City, Kanagawa 225-0012, Japan

TEL : +81-(0)45-913-5544 FAX : +81-(0)45-913-5802

Email : tu.tokieda@shoko-sc.co.jp

[http : www.shoko-sc.co.jp](http://www.shoko-sc.co.jp)

[NORTH & LATIN AMERICA]

Showa Denko America, Inc.

420 Lexington Avenue, Suite 2335, New York,
NY 10170 ,USA

Tel : +1 212 370 0033

Fax : +1 212 370 4566

E-mail : support@shodex.net

URL:<http://www.shodex.net/>

[EUROPE & AFRICA]

Showa Denko Europe GmbH

Konrad-Zuse-Platz 4, D-81829 Munich, Germany

Tel : +49 (0)89 93 99 62-37

Fax : +49 (0)89 93 99 62-50

E-mail : info@shodex.de

URL :<http://www.shodex.de/>

[CHINA]

Shodex China Co., Ltd.

18F, Wang Wang Building, No.211 Shi Men
Yi Road, Jing An, Shanghai, 200041, P.R.China

Tel : +86 (0)21 6217-6111

Fax : +86 (0)21 6217-9879

E-mail : sales@shodexchina.com

URL :http://www.shodex.com/index_ch.html

[KOREA]

Shoko Korea Co., Ltd.

#322, Chungjeong Rizion, 465, Chungjeongno 3-ga,

Seodaemun-gu, Seoul 120-013 Korea

Tel : +82 (0)2 784 5111

Fax : +82 (0)31 790 4149

E-mail : shoko.korea@shokokorea.com

URL :http://www.shodex.com/index_kr.html